

Difusores

Difusor Linear



Difusores com instalação recomendada em tetos, podendo ser fornecidos com até quatro aberturas (slots). Proporciona uma distribuição uniforme do ar insuflado, com controle de direção do ar na vertical e horizontal mediante ajuste das palhetas.

Fabricado em perfis de alumínio extrudado, com acabamento padrão anodizado fosco natural, ou quando solicitado com pintura à base de epóxy-pó, em cores sob consulta.

Podem ser fornecidos com caixa plenum.

Modelos

DL 1S – Difusor linear com um slot.

DL 2S – Difusor linear com dois slots.

DL 3S – Difusor linear com três slots.

DL 4S – Difusor linear com quatro slots.

Modelos e Dimensões

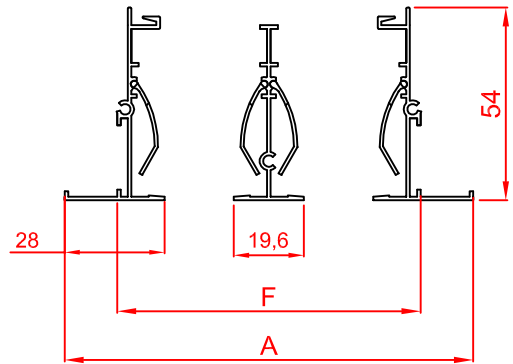
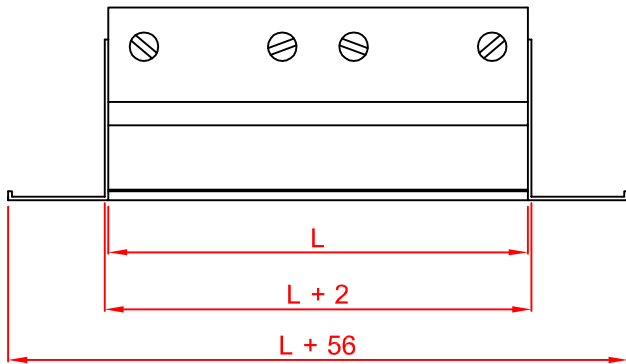

DL 1S

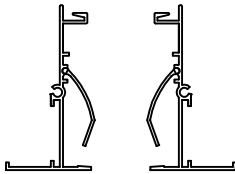

F	A
46	75,4

DL 2S

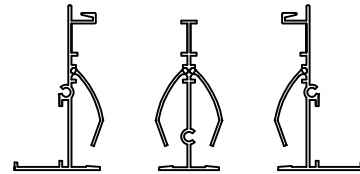

F	A
85	114,4

DL 3S

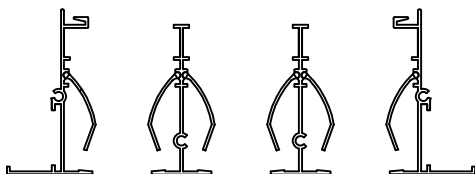

F	A
124	153,4

DL 4S

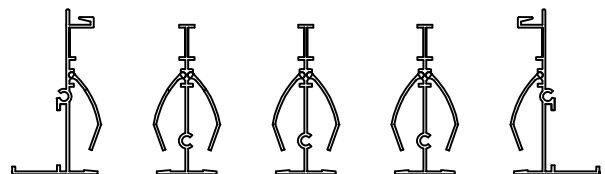

F	A
163	192,4

Para o pedido devem ser fornecidas a medida de comprimento e o modelo desejado.

Dados de Seleção

Tabela 1: Vazão por metro Linear									
Fluxo	Vertical				Horizontal				
Slots	1	2	3	4	1	2	3	4	
Área de passagem (m ²)	0,019	0,039	0,058	0,078	0,009	0,017	0,026	0,034	
Vazão (m ³ /h·m)	63	126	189	251	28	55	83	110	v (m/s)
	70	140	210	279	31	61	92	123	
	105	210	314	-	46	92	138	184	
	140	279	-	-	61	123	184	245	
	175	-	-	-	77	153	230	306	
									0,9
									1
									1,5
									2
									2,5

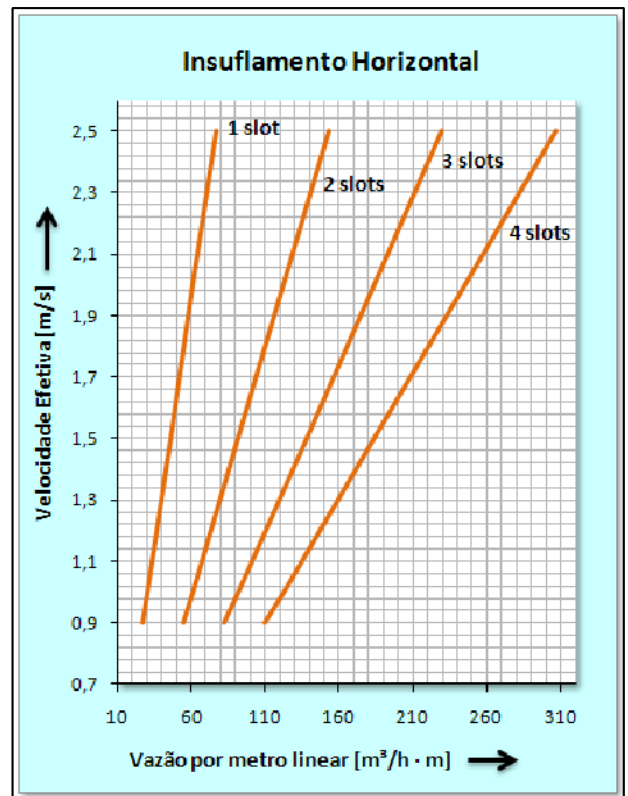
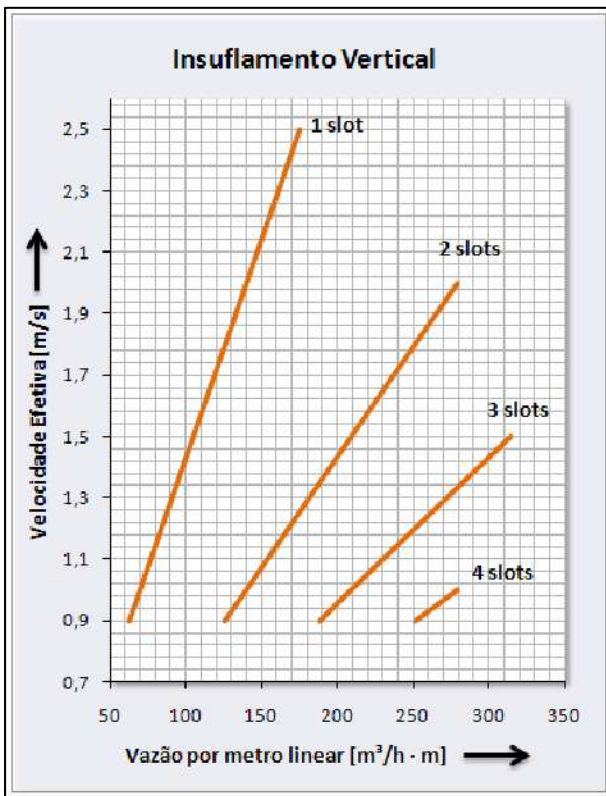

Fluxo

Vertical

Horizontal

